



 **2+** |
  **20** |
  **1,37m** |
  **1 = 5,6m 2 = 4,2m 3 = 3m**

 Motor disability
 Sensorial disabilities
 Learning disabilities



Play value : 9

climbing

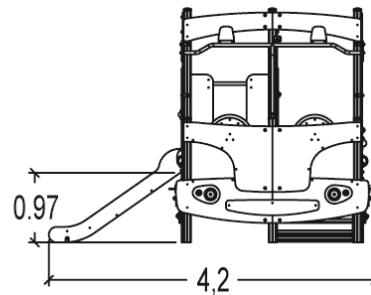
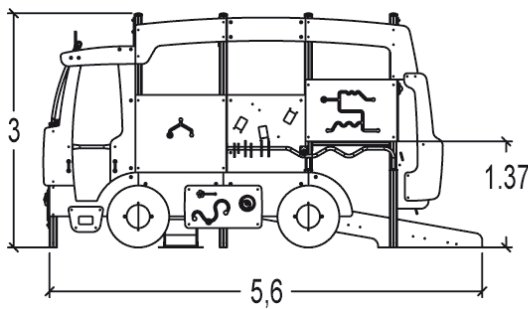

x1

role play



x1

sliding



x1

meeting



x1

handling



x1

thinking



x1

tactile stimulation



x1

visual stimulation



x1

climbing



x1

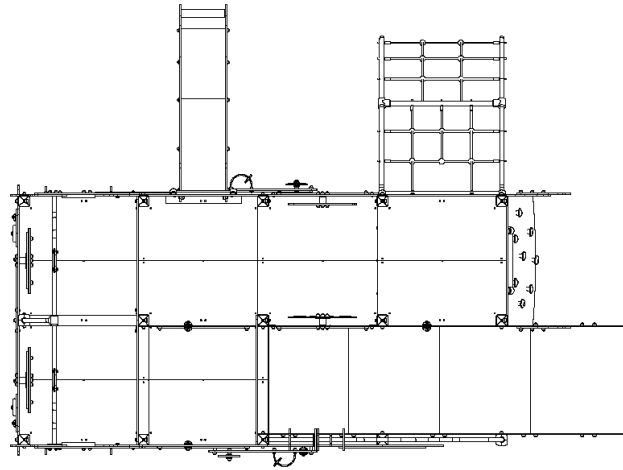



Installation of equipment

Impact area =

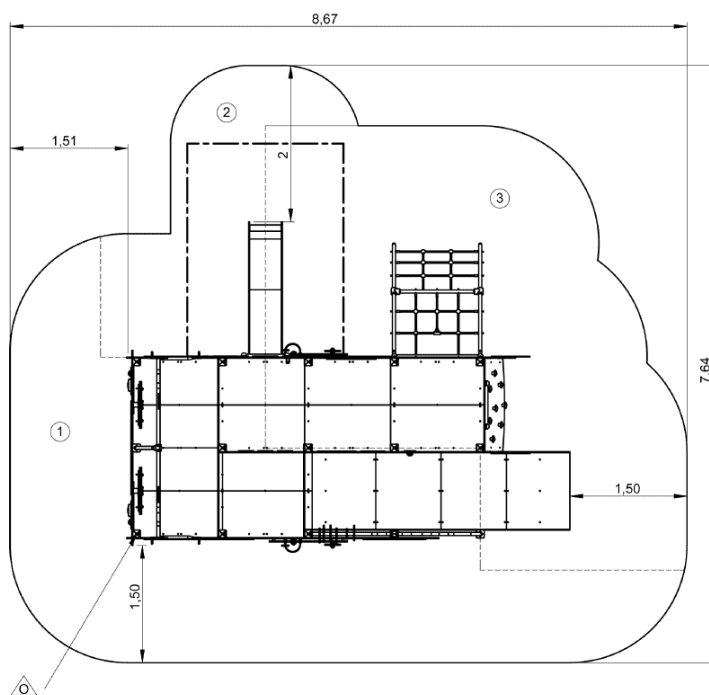
 Impact area
 Free space



		
1	0,6m	24m ²
2	1m	6,5m ²
3	1,37m	23m ²



2



24h00



0m³



53.5m²



1351kg



20kg

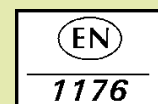

Proludic

2015-07-31