

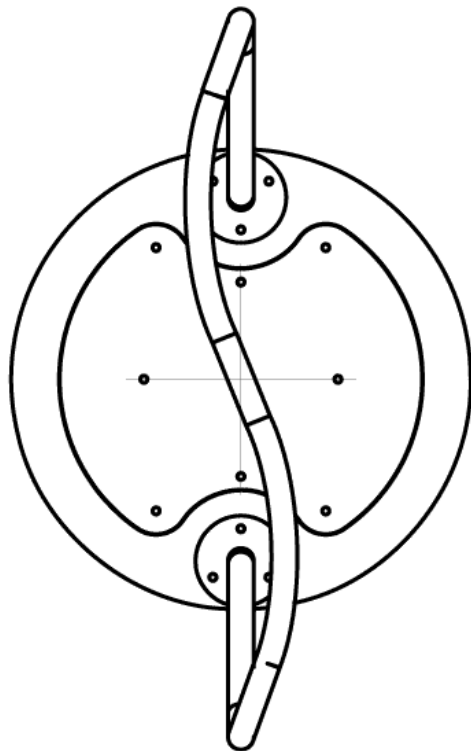

1=0.84m 2=0.84m 3=1.5m

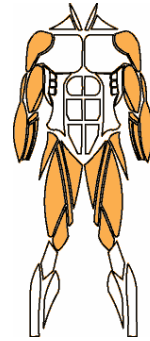

**MUSCULAR STIMULATION**



**INTENSITY OF EFFORT**



**ENERGY EXPENDITURE**

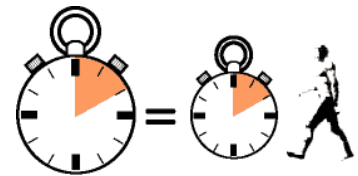

**DIMENSIONS & MOVEMENTS**

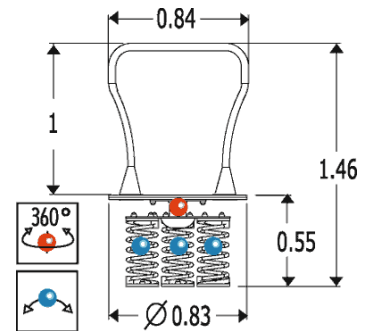

**OTHER INFORMATION**



4 players

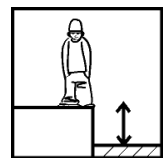

HCL= 0.55m

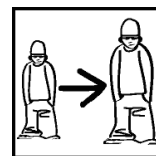

8+

**Installation of equipment**

Impact area =

 Impact area

 Free space

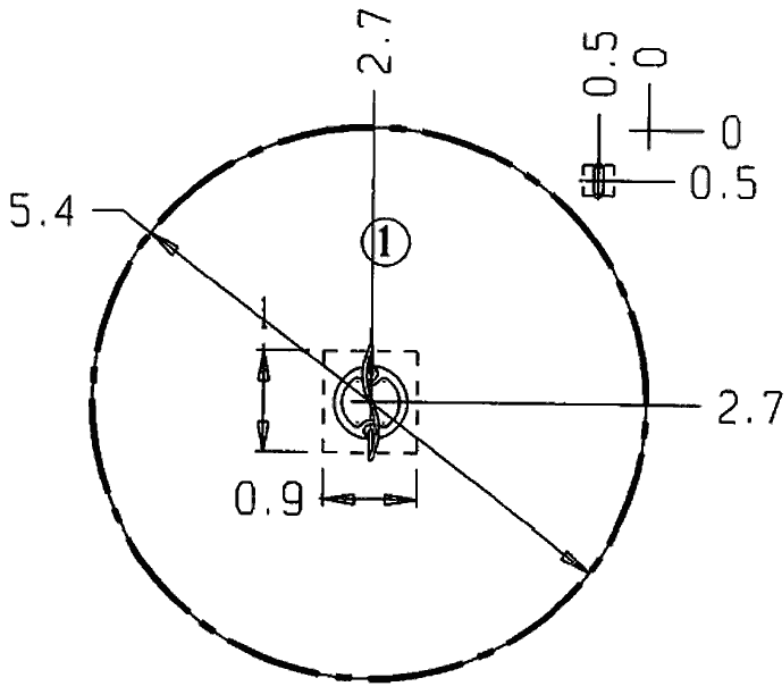

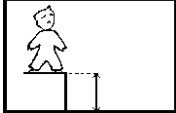
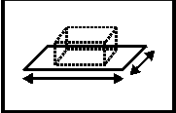
|   |   |                  |
|---|---|------------------|
|  |  |                  |
| ①   | 0,55m   | 23m <sup>2</sup> |

**INSTALLATION**



2

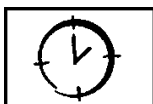

01h00

**CERTIFICATIONS**

