

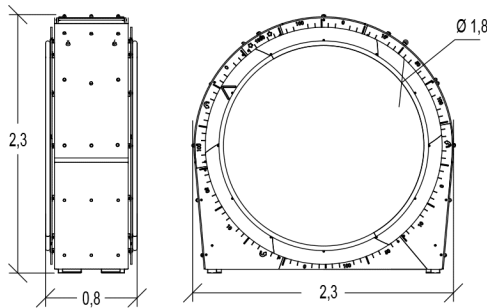

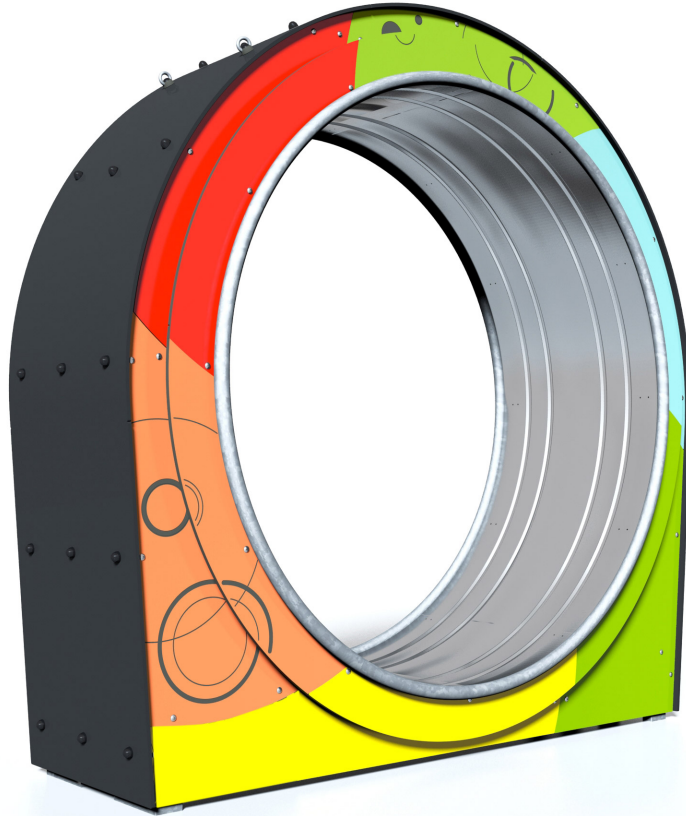



**6+** | **3** | **0,7m** | **1 = 0m 2 = 0m 3 = 0m**

 Motor disability     
 Sensorial disabilities     
 Learning disabilities



Play value : **5**



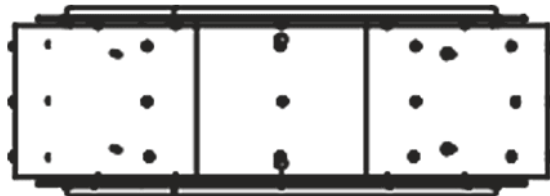







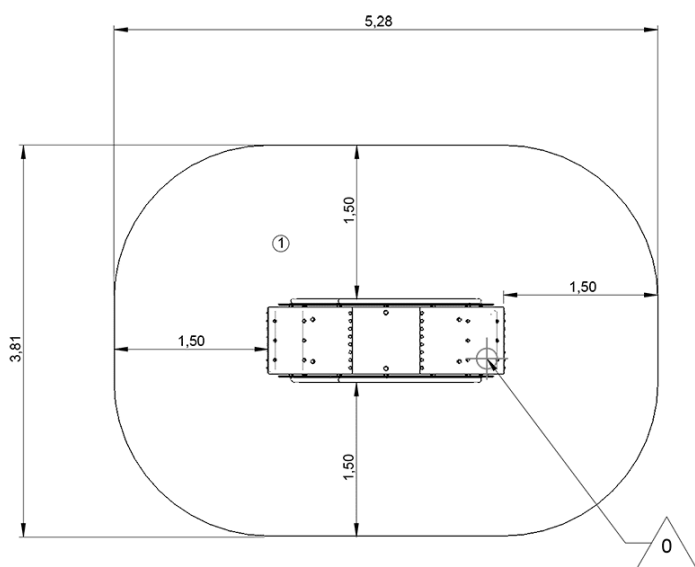









## Installation of equipment

Impact area =

-  Impact area
-  Free space



		
1	0,7m	18,5m <sup>2</sup>

								
2	04h00	0.5m <sup>3</sup>	18.5m <sup>2</sup>	400kg	361kg			0000-00-00