



2+



2



0,5m



1 = 1,57m 2 = 0,43m 3 = 0,72m



Motor disability

Sensorial disabilities

Learning disabilities

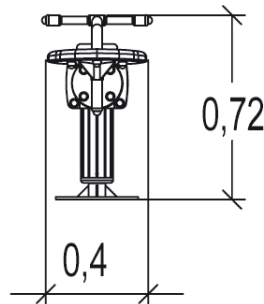
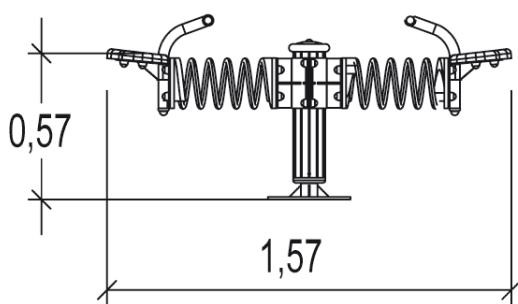
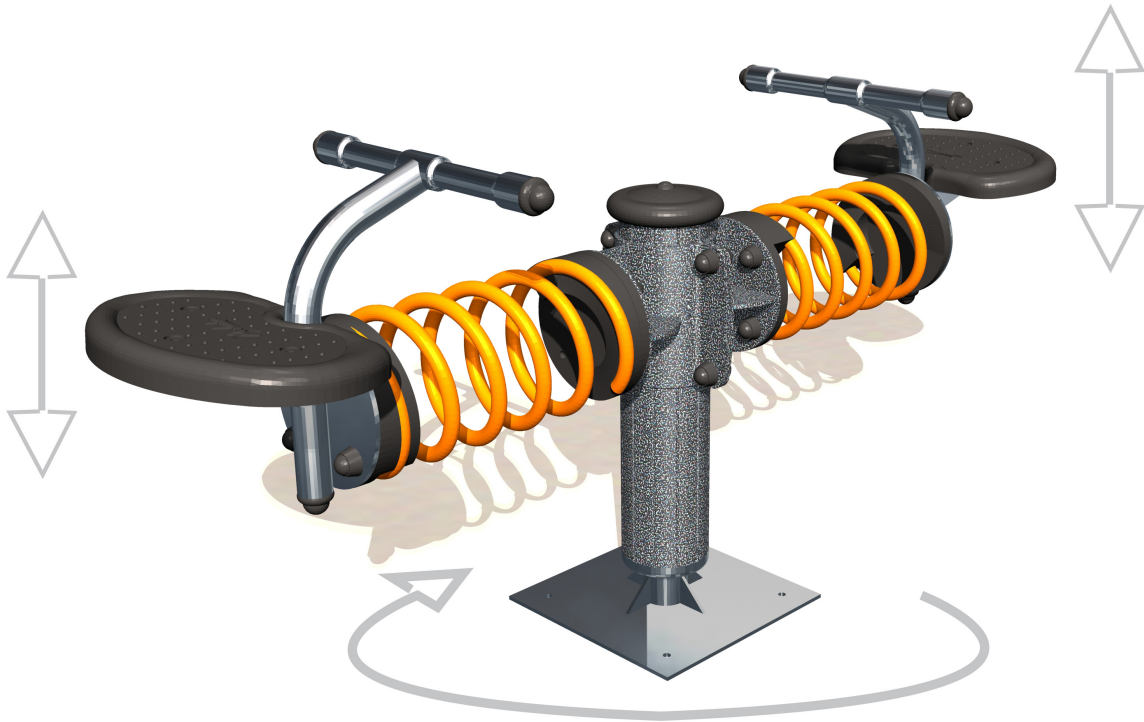
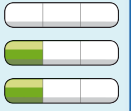

Play value : 3

swinging



balancing



rotating



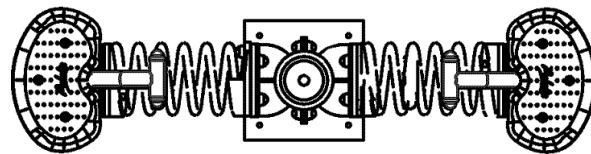







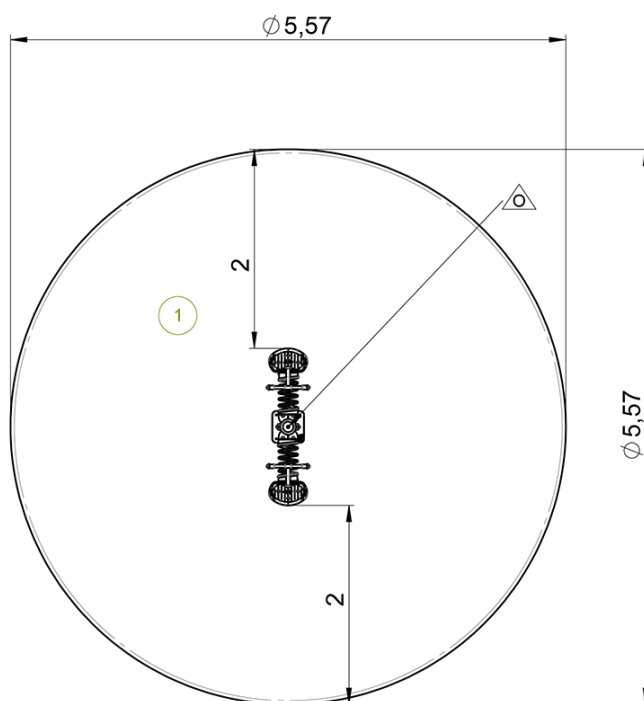



Installation of equipment

Impact area =

-  Impact area
-  Free space



		
1	0,5m	24,5m ²

							
2	02h00	0.2m ³	24.5m ²	69kg	58kg		2007-01-01