

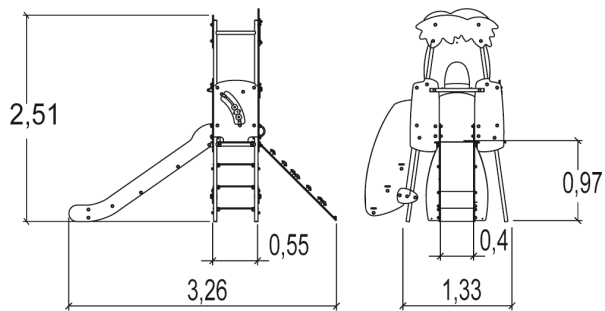

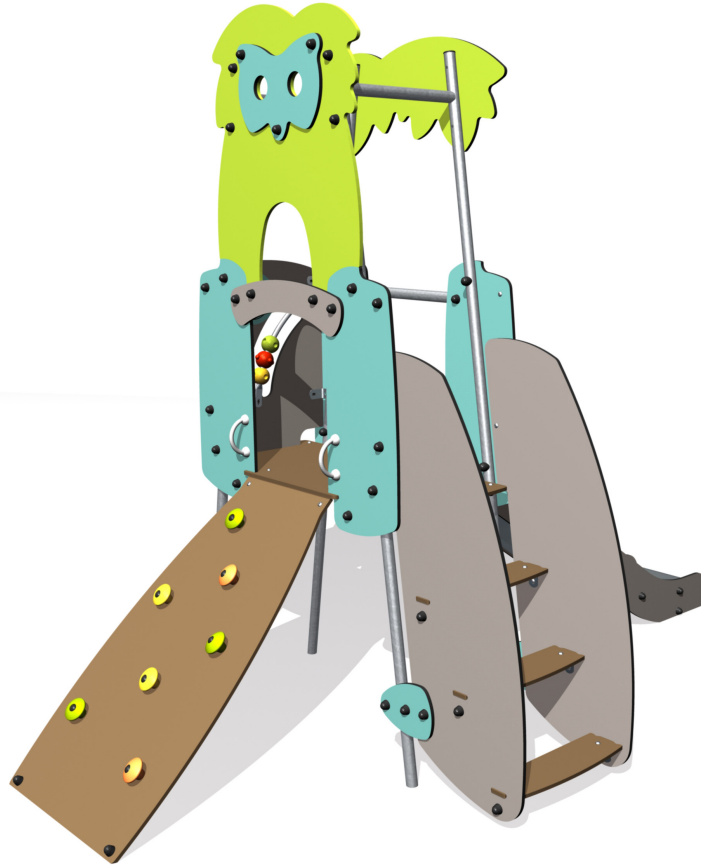





2+ | **10** | **1m** | **1 = 3,25m 2 = 1,55m 3 = 2,6m**

 Motor disability
 Sensorial disabilities
 Learning disabilities



Play value : **8**

climbing  x1	role play  x1	sliding  x1	meeting  x2	handling  x1	visual stimulation  x1	climbing  x1
---	--	--	--	---	--	---

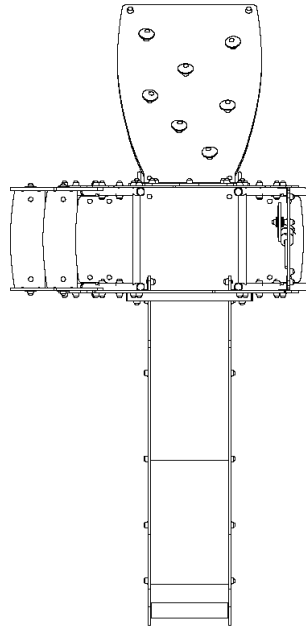



Installation of equipment

Impact area =

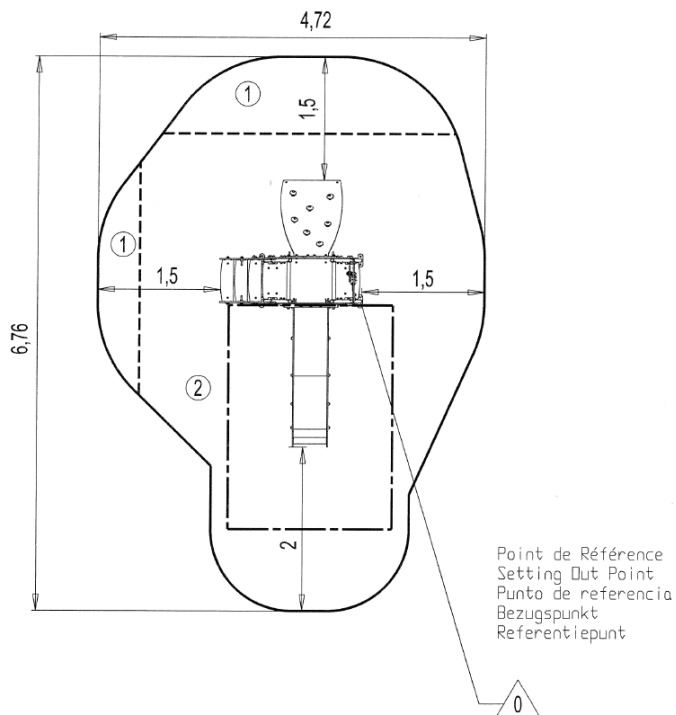
-  Impact area
-  Free space



		
1	0,6m	3,5m ²
2	1m	20m ²



2



03h00



0m³



23.5m²



173kg



14kg

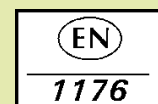

Proludic

0000-00-00