



3+



20



1,7m



1 = 5,5m 2 = 4,81m 3 = 2,8m



Motor disabilities  
 Sensorial disabilities  
 Learning disabilities

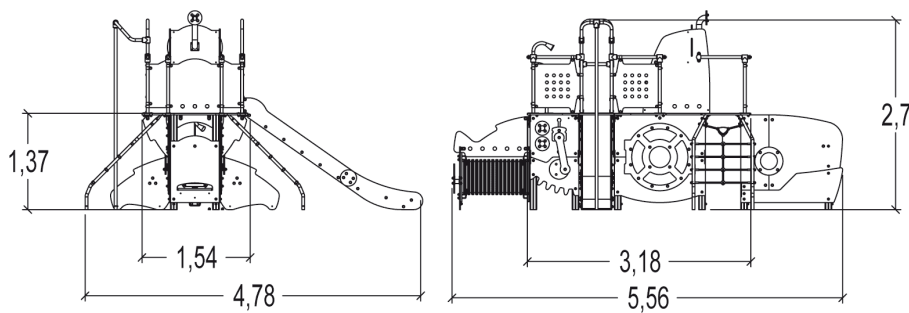
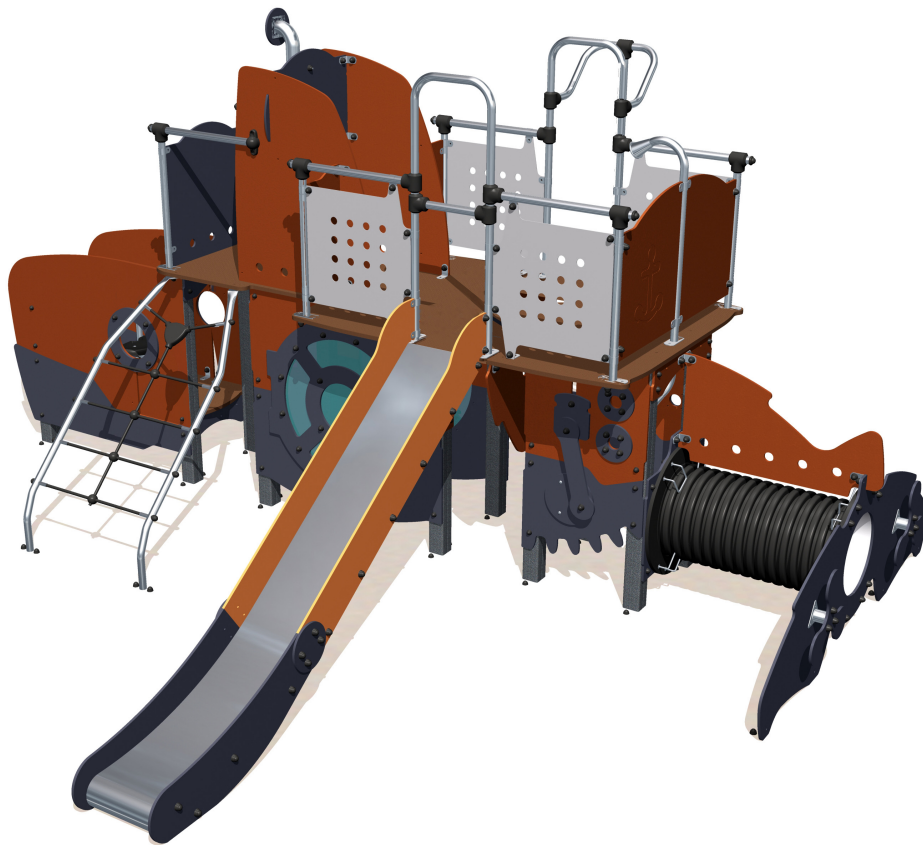
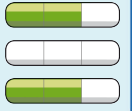

Play value :

14

role play



x1

sliding



x3

meeting



x1

resting



x1

handling



x1

crawling



x1

hiding



x1

thinking



x1

sound stimulation



x1

visual stimulation



x1

climbing



x2

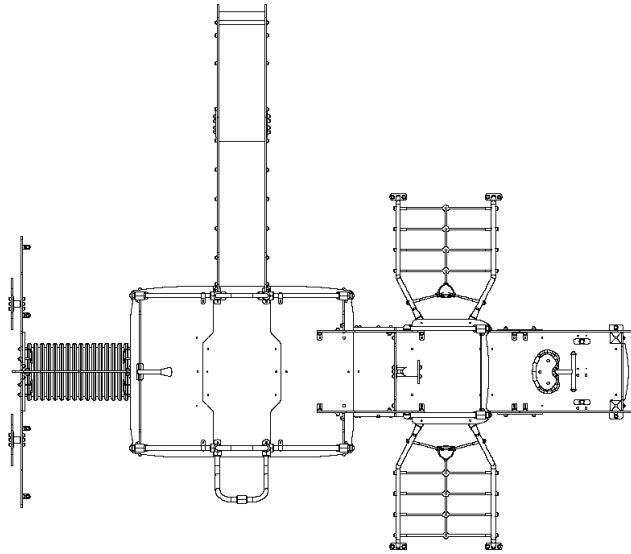



## Installation of equipment

Impact area =

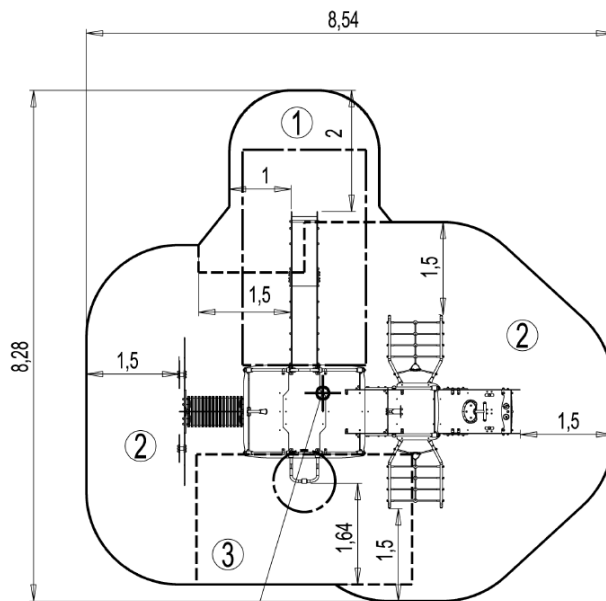
 Impact area  
 Free space



 Point de Référence  
 Setting Out Point  
 Punto de referencia  
 Bezugspunkt

		
1	1m	6,5m <sup>2</sup>
2	1,37m	36,5m <sup>2</sup>
3	1,7m	7,5m <sup>2</sup>



2



40h00



0.9m<sup>3</sup>



50.5m<sup>2</sup>



771kg



26kg

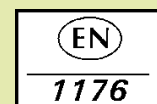

*Proludic*

2010-02-04