



3+



20



2m



1 = 6,53m 2 = 4,14m 3 = 3,53m



Motor disabilities  
Sensorial disabilities  
Learning disabilities

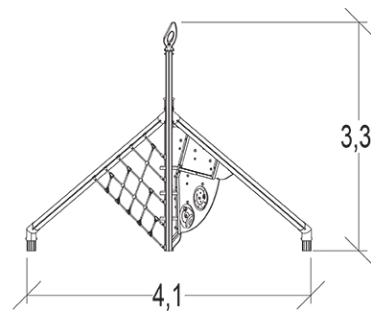
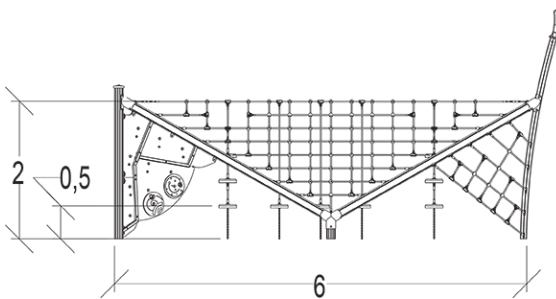
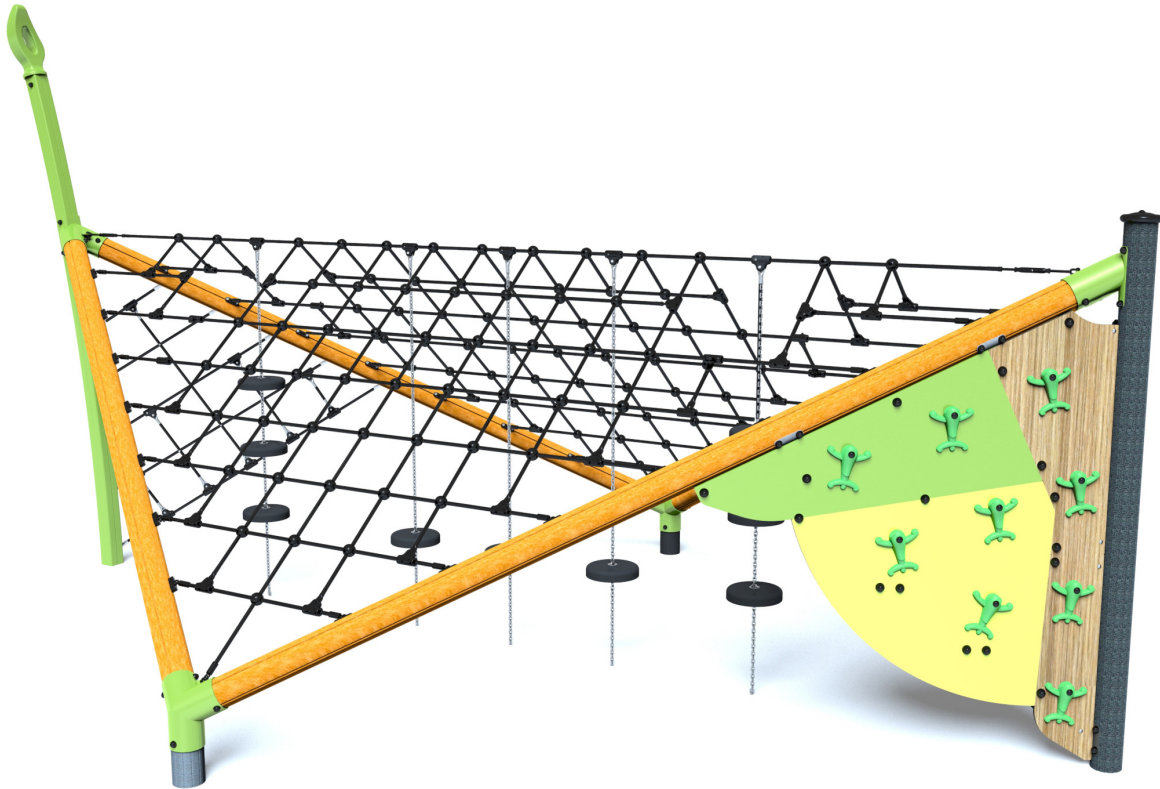
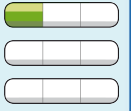

Play value : 13

climbing



x1

meeting



x2

resting



x1

handling



x1

hiding



x1

sound stimulation



x1

climbing



x4

getting across



x2

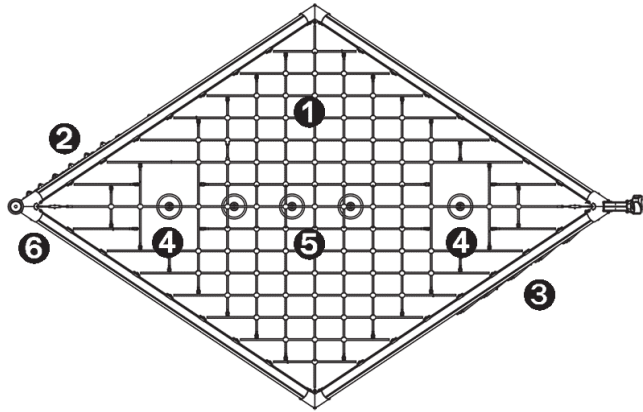

- 1 Open Net
- 2 Climbing wall
- 3 Small net
- 4 Climbing rope
- 5 Suspended seat
- 6 Acoustic play pannel

## Installation of equipment

Impact area =

- Impact area
- Free space

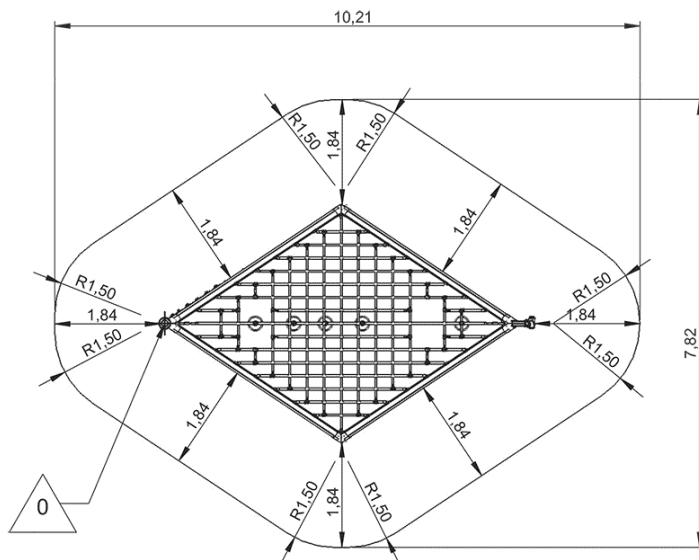

|   |    |                  |
|---|----|------------------|
|   |    |                  |
| 1 | 2m | 52m <sup>2</sup> |



2



08h00



1m<sup>3</sup>



52m<sup>2</sup>



488kg



37kg

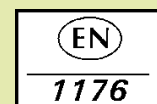

0000-00-00