



2-8



1



0,6m



1 = 0,58m 2 = 0,4m 3 = 0,84m



Motor disability

Sensorial disabilities

Learning disabilities

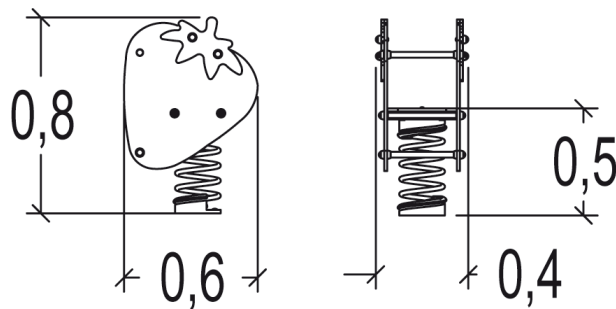
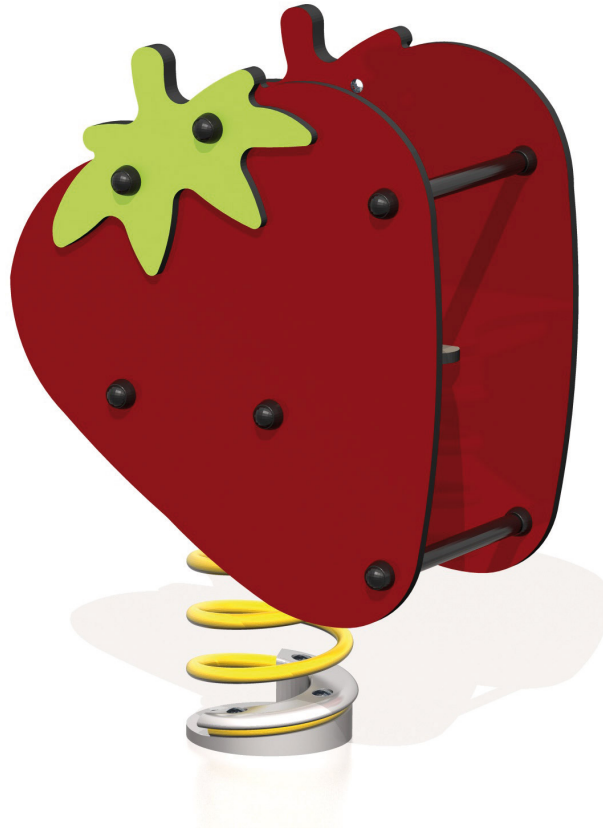
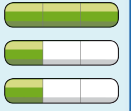

Play value : 2

swinging



balancing



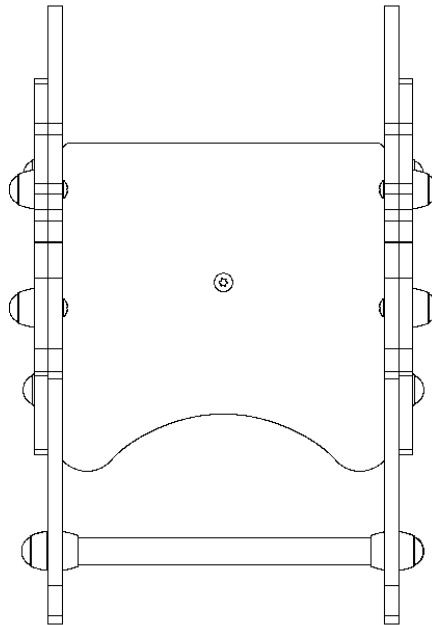



## Installation of equipment

Impact area =

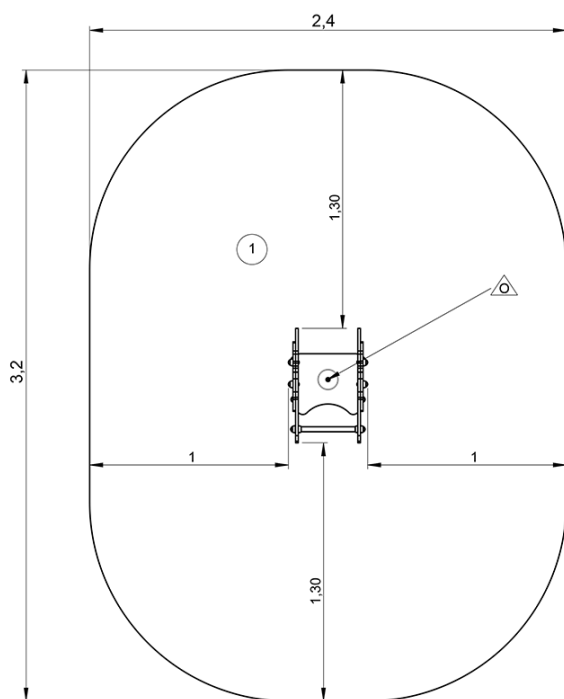
 Impact area  
 Free space



	
1	0,6m
	7m <sup>2</sup>



1



01h00



0m<sup>3</sup>



7m<sup>2</sup>



33kg



11kg

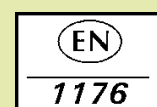

*Proludic*

2016-01-08