

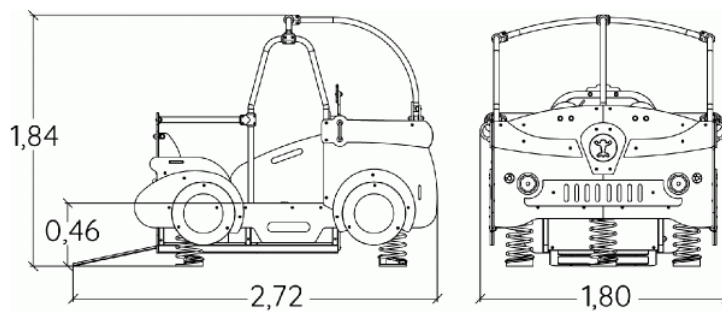









Motor inclusion
Sensory inclusion
Mental inclusion



Play value : **20**

role play	meeting	resting	handling	balancing	thinking	sound stimulation	tactile stimulation
							
x1	x1	x1	x5	x1	x2	x2	x5
visual stimulation	Oscillate						
							
x1	x1						



Installation of equipment

IMPORTANT: It is essential to refer to the installation instructions for information on the size of the safety areas.

———— Impact area (minimum normative surface)

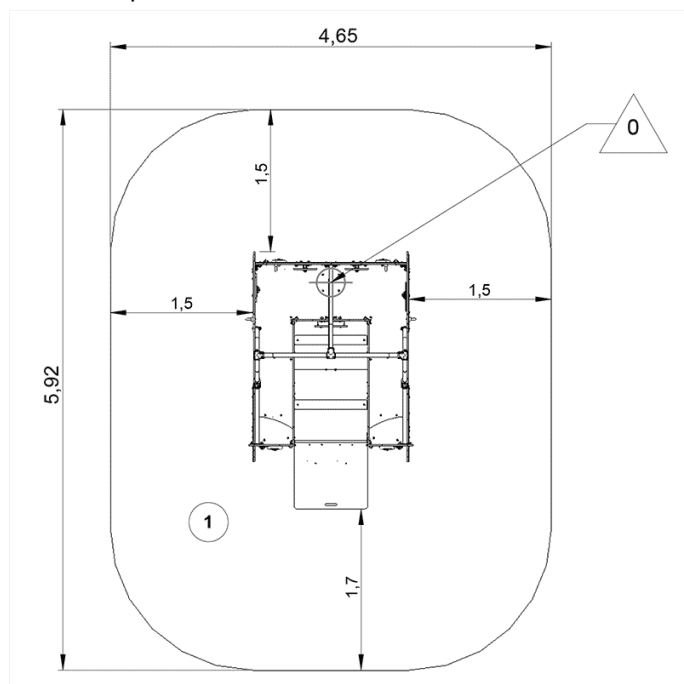
- - - - - Free space



		
1	0,46m	26m ²



2

04h00

0m³

26m²

374kg

28kg

EN

1176